

## Manual for 2-wire LED display and control unit



LP-LED-01



### 1. Brief

The TPP LE series universal intelligent 2-wire LED digital display is fit for all of the transmitters and converters with 4~20mA 2-wire technique, just as pressure, differential pressure, temperature, flow, PH, acceleration and so on. 16 Bit ADC MCU inside. The two buttons are used to program the zero point, Span, decimal point, damping and alarm point etc. instead of the potentiometer.

### 2. Feature

- 1) 2-wire, no additional power supply required, just as traditional LCD display.
- 2) Visible in the dark environment.
- 3) 16 Bit ADC MCU inside.
- 4) The scope of the value can be displayed on the LED is -1.9.9.9. ~ 9.9.9.9.
- 5) LED can work at 3mA
- 6) Two OPTO switch outputs.

### 3. Setting

\* In the following description, “A” denote the button“ $\wedge$ ”, “B” denote the button “ $\vee$ ”, and “A+B” denote pressing the button “ $\wedge$ ” and button “ $\vee$ ” at the same time.

#### 3.1 power on

After the digital LED display was connected to the current circle 4~20mA, the name of the manufacturer is displayed, and enter into the interface of display.

#### 3.2 Zero-point (value to be displayed for 4mA)

Press button “A+B”, unit 

S	E	L	2
---	---	---	---

 is displayed.

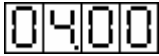
→ “A+B” menu item for setting: 

→ “A” to move the cursor, “B” to change the value that the cursor point to.

For example: -100.0Kpa. 

→ “A+B” to confirm and store setting and return to the menu item.

### 3.3 Span(value to be displayed for 20mA)

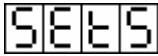
Press button “A”, unit  is displayed.

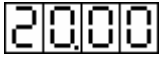
→ “A+B” menu item for setting: 

→ “A” to move the cursor, “B” to change the value that the cursor point to.

For example: 100.0Kpa 

→ “A+B” to confirm and store setting and return to the menu item.

### 3.4 decimal point

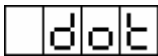
Press button “A”, unit  is displayed.

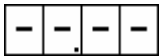
→ “A+B” menu item for setting: 

→ “A” to move the decimal toward left, “B” to move the decimal toward right.

→ “A+B” to confirm and store setting and return to the menu item.

### 3.5 Damping

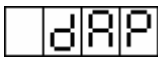
Press button “A”, unit  is displayed.

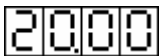
→ “A+B” menu item for setting: 

→ “A” to move the cursor, “B” to change the value that the cursor point to.

(Min=0s, Max=29.5s, step 0.5s)

→ “A+B” to confirm and store setting and return to the menu item.

### 3.6 Alarm

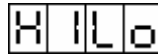
Press button “A”, unit  is displayed.

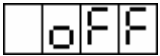
→ “A+B” menu item for setting: 

→ “A” or “B” to change the setting either “on” or “off”. “on” means the parameter followed is valid, and the Alarm was expressed by the twinkle of the last decimal point. And “off” cancel the alarm function.

→ “A+B” to confirm and store setting and return to the menu item.

### 3.7 The first alarm point

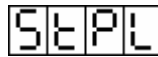
Press button “A”, unit  is displayed.

The method of setting is the same as step 3.2

### 3.8 The second alarm point

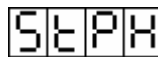
Press button “A”, unit  is displayed.

The method of setting is the same as step 3.7.

### 3.9 The direction of the first alarm point

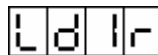
Press button “A”, unit  is displayed.

→ “A+B” menu item for setting: 

→ “A” or “B” to change the setting either “up” or “dn”. “UP” means alarm while the value is above the alarm parameter, and “Down” means alarm while value is below the alarm parameter.

→ “A+B” to confirm and store setting and return to the menu item.

### 3.10 the direction of the second alarm point

Press button “A”, unit **Hd Ir** is displayed.

Other is the same as 3.9.

### 3.11 The delay

Press button “A”, unit **dELA** is displayed.

→ “A” menu item for setting.

→ “A” to move the cursor, “B” to change the value that the cursor point to.

(Min=0s, Max=39.5s)

→ “A+B” to confirm and store setting and return to the menu item.

→ “A” return to the original interface. And all setting is completed.

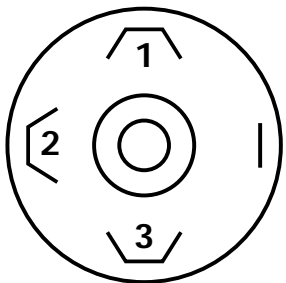

- 1) Supply + (Red)
- 2) Signal -(Black)
- 3) Empty

## 4 Dimensions

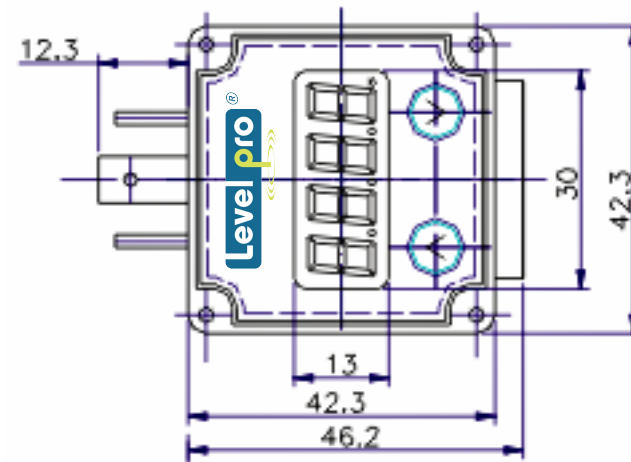
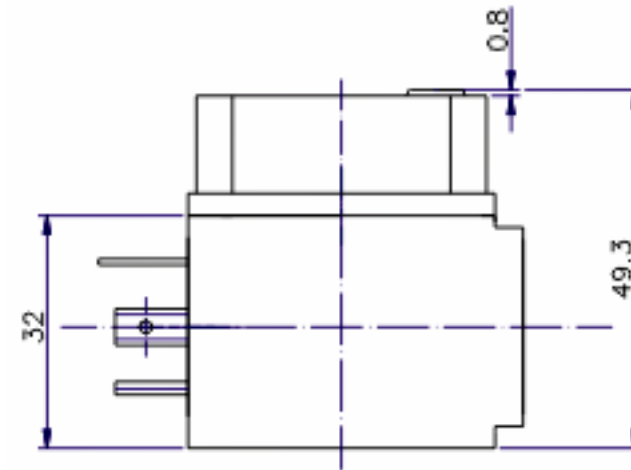

LP LED-01

