

Quick Start Manual

(Industry's Toughest Built Paddle Wheel Flow Meter)

No K-Factor Programming



BATTERY OPERATED TKB SERIES

- Flow Rate + Flow Totalizer
- 2 Levels of Password Security
- Programmable Time On Backlight
- No Tools Required



Read the User's Manual Carefully before Starting to Use the Unit.

All TK Series Flow Meters are Factory Calibrated and do not require K-flow Factor Programming.

Manufacturer reserves the right to implement changes without prior notice.

Instruction Manual

TKB Series Battery Operated LCD Flow Meter

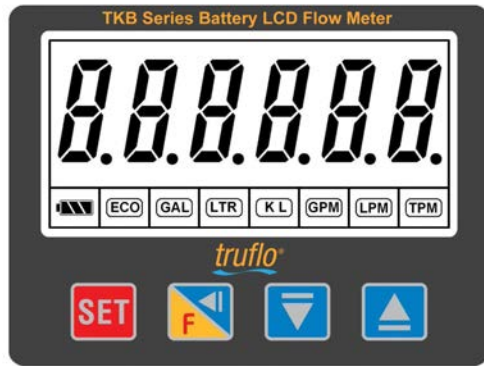

FEATURES

1. Energy Saving 'ECO' mode option
2. Units of Measurement
 - 2-1. Flow rate : GPM → LPM → TPM (Range=0.0~999.9)
 - 2-2. Totalizer : GAL → LTR → KL (Range=0~99,999,999)
3. Totalizer Reset protection
4. Four Directions for Installation-90 Degrees
5. Low battery Indication
6. Eprom Memory- Retains Setting during battery changeout

Model Selection

TKB - 15 - PF - E - S				
1	2	3	4	5
1	Series	「TKB」 = Battery Operated LCD Flow Meter		
2	Pipe size	「08」 = 「DN08 (1/4)」* / 「10」 = 「DN10 (3/8)」* / 「15」 = 「DN15 (1/2)」 / 「20」 = 「DN20 (3/4)」 「25」 = 「DN25 (1)」 / 「40」 = 「DN40 (1 1/2)」 / 「50」 = 「DN50 (2)」 / 「65」 = 「DN65 (2 1/2)」 「80」 = 「DN80 (3)」** / 「100」 = 「DN100(4)」**		
3	Body Material	「PVC」 = PVC / 「PP」 = PP / 「PF」 = PVDF / 「ST」 = SUS 316		
4	O-Rings Seals	* VITON (Std) E = EPDM		
5	End Connections	S=Socket (PVC Std), T=NPT (SST Std), SDR11 Butt (PP, PVDF Std) F=Flange		

* SST Version Only

** Plastic Versions Only

General Data

Specification	Description
Fluid	Water or Chemical Liquid-Viscosity Range: .5-20 centistokes
Accuracy	± 0.5% of F.S. @ 25°C
Flow velocity	10 m / s max
Low cut	0.3 m / s min.
Operating press.	150 PSI (10 Bar) @ Ambient Temp-Non Shock
Range ability	10 : 1
Response time	Real time
Material	Paddle : Tefzel : Body : PVC / PP / PVDF / SUS 316 : Shaft/Rotor : Zirconium Ceramic
Operating temperature	「PVC」 < 60°C / 「PP」 < 80°C / 「PVDF」 < 110°C / 「ST」 < 120°C
Operating Circumstance	-20°C ~ +80°; 35% ~ 85% RH
Protection Class	NEMA 4X IP-66
Approval	CE Rohs

Specification	
Product	TKB Series Battery Operated LCD Flow Meter
Model	TKB-□□□
Flow total meter	Range = 0~999999 ; Unit = Gallon or Liter or Ton (KL) Selectable
Flow rate meter	Range = 0.0~999.9 ; Unit = GPM or LPM or TPM Selectable
Operating voltage	3.0 VDC
Battery	Lithium battery (CR2477T)
Life of battery	>1 Year Normal >2 Years Eco Mode
Housing material	Polycarbonate (UL-94V0)

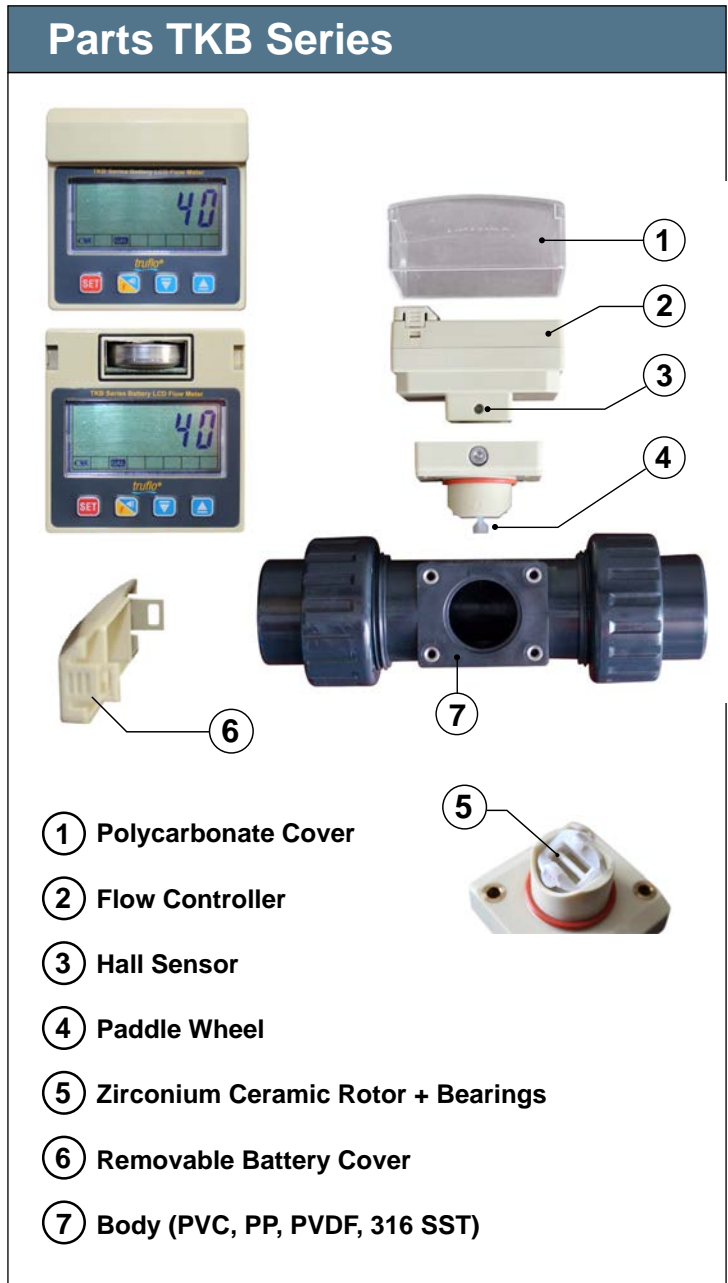
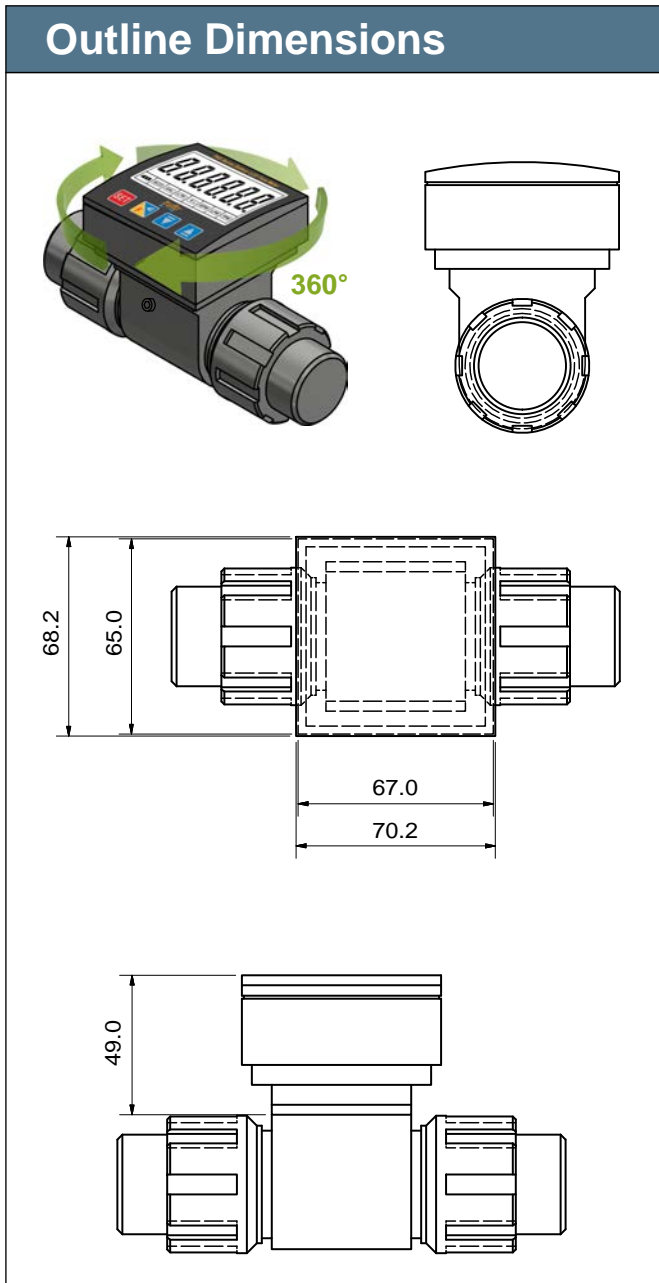













Programming

Status / Display	Range	Description
<div style="border: 1px solid black; padding: 5px; margin-bottom: 5px;"> Flow Totalizer or Flow Rate 123456 or 1234.5 </div> Press ENT & F Key for 3 sec	0~999999 or 0.1~9999.9	1. Running Status (ON) 2. Flow Total (Totalizer) 3. Flow Rate
<div style="border: 1px solid black; padding: 5px; margin-bottom: 5px;"> Lock setting Lock-8 </div> Press SET key	Selectable 0~9	Factory Unlock Number = 8 Select Display Lock Number = 0-9 to Lockout
<div style="border: 1px solid black; padding: 5px; margin-bottom: 5px;"> K factor setting K9999.9 </div> Press SET key	Factory Set	1>Coefficient of Flow meter = Input pulses x 「1/k」 * Only required if changing displays-to another pipesize i.e. 1" size to 2" pipe size
<div style="border: 1px solid black; padding: 5px; margin-bottom: 5px;"> Display mode dSP.Eco </div> Press SET key	Selectable dSP-Eco dSP-non	1> 「dSP-Eco」 = Press any key to turn on the LED back light (Note: Battery Life Reduced) 2> 「dSP-non」 = The LED back light will turned on when any button is pressed
<div style="border: 1px solid black; padding: 5px; margin-bottom: 5px;"> Light -On t-0 </div> Press SET key	Selectable 1~9999	1< 「t-0006」 = Set Duration Time (Sec) of back light. Press any key to turn on the disply to turn on LED light (> Time = Reduced Battery)
<div style="border: 1px solid black; padding: 5px; margin-bottom: 5px;"> Alarm delay setting dt-10 </div> Press SET key	Selectable 1~9999	1> 「dt.10」 = Alarm ON delay 10 seconds Flow rate meter : (r xxxx.x)<(L nnnn.n) or (r xxxx.x)>(H yyyy.y) Delay 10 seconds to exchange display of flow rate value & alarm value.
<div style="border: 1px solid black; padding: 5px; margin-bottom: 5px;"> Reset Totalizer rESEt.5 </div> Press SET key	Selectable 0~9	1. Password Setting Select Numbers 0-9 (ex 5) = Flow Totalizer Reset Protection Active-Reset is disabled 2. 「rESEt.」= 5 = Flow Totalizer Reset Enabled

See next Page for Flow Alarm Programming Functions

Programming Flow Rate (High-Low) Alarm

Status / Display	Range	Description
 Press  &  Key for 5 sec	0~999999 or 0.1~9999.9	1. Running Status (ON) 2. Flow Total (Totalizer) 3. Flow Rate
 Press  key	Selectable H-9999	Enter (High) Flow Rate Value * Select Value Above Normal Flow Rate
 Press  key	Save Value 1~9999	Saving (High) Flow Rate Value for Alarm Notification
 Press  key	Save Value 1~9999	Enter Low Flow Alarm Value * Select Value Below Normal Flow Rate
 Press  key	Save Value 1~9999	Saving (Low) Flow Rate Value for Alarm Notification
Press  key	Programmed Value 1~9999	In alarm Mode- Display will Flash if current flow is lower than Programmed Low Rate (r xxxx.x)<(Lllll. l) or current rate is higher than Programmed High Rate (r xxxx.x)>(H-hhhh.h)

TKB Normal Operation



1. Battery Saving Mode

- 1-1. 「dSP-non」 = Press any key to turn on the LED light for (x) second duration.
- 1-2. 「dSP-Eco」 = The back light LED will be turned off normal use.



2. Viewing Flow Rate/Flow Total (Selecting Engineering Units) :

Press  SET Key for 3 Seconds, then press  or  to select

GPM → LPM → TPM → GAL → LTR → TON → GPM →

2-2. GPM → LPM → TPM = (Engineering Units - Flow Rate Display Screen)

2-3. GAL → LTR → TON = (Engineering Units - Flow Total Display Screen)

⚠ 3. Display the Current Value of Flow Totalizer : Range 0~99,999,999

3-1. Please press the  key 3 seconds to show current value of the 7th ~ 8th digits

3-2. After releasing the  key the current value of the 1st ~ 6th digits will be displayed

Press  &  Keys 3 seconds to Reset Flow Totalizer

⚠ 4. How to set the alarm limit of Flow rate meter?

4-1. Press the **SET** &  keys 3 seconds to display High alarm limit setting value 「H yyyy.y」

4-2. After finishing the High alarm limit setting , Press the **SET** key to display Low alarm limit setting value 「L nnnn.n」

4-3. Set 「H0.0」 to close the alarm function





4-4. In alarm status (r xxxx.x)<(L nnnn.n) or (r xxxx.x)>(H yyyy.y): 「r. xxxx.x」 & 「L nnnn.n」 or 「H yyyy.y」 exchange display

⚠ 5. Totalizer Reset (Password Protection Feature) - (See Above)

5-1. The Flow Total (Totalizer) can be Protected from an Accidental Reset. To lockout program any number from 0-9 exc (# 5) The Unlock Number = (5) Factory Programmed

Press  &  Keys 3 seconds to Reset Totalizer)

⚠ 6. Low battery Notification

Voltage of battery	Symbol of battery	Status
3.0V		Full scale
< 3.0V		Mild scale
<2.8V		Low scale (Pilot BAT flashing)
<2.6V		Low voltage (Pilot BAT & Display flashing)

⚠ 7. Displaying Flow Rate-Flow Totalizer

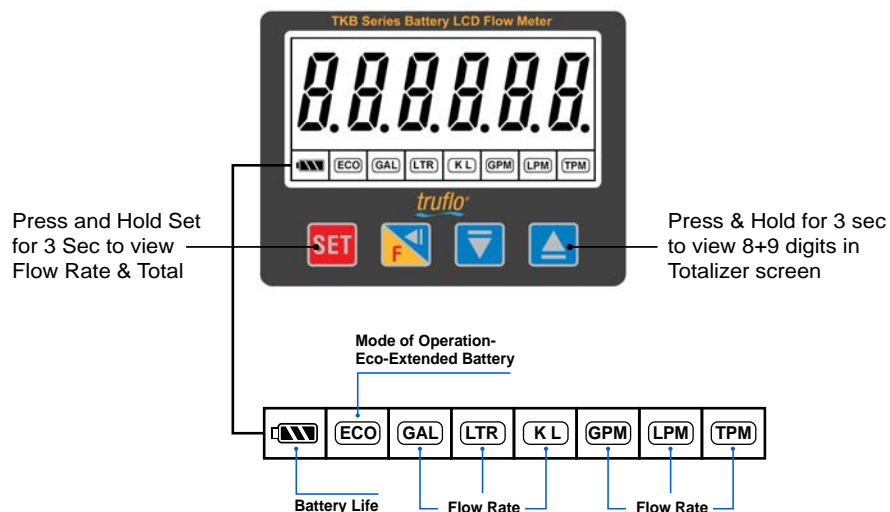

K-Factors for TK Series Flow Meters (All Models)

Size	Gallons	Liters
1/2"	124	32.6
3/4"	72	18.9
1"	54	14.2
1 1/2"	19	5.0
2"	10.3	2.7
3"	4.7	1.2
4"	2.1	0.6

1. Required when programming remote display or controller.

K-Factor Pre Programmed by Factory - No Flow Meter Programming of a K-Factor is required.

Standard Pipe Size

Pipe Size (O.D.)	ANSI (ID) (Inches)		DIN (ID) (mm)	Flow Rate (LPM) / USGPM	
	Sch (40)	Sch (80)		0.3m/s min.	10m/s max.
DN15 (1/2")	0.62	0.55	Ø20	3.5 / 1.0	120 / 32
DN20 (3/4")	0.82	0.74	Ø25	5.0 / 1.5	170 / 45
DN25 (1")	1.00	0.96	Ø32	9.0 / 2.5	300 / 79
DN40 (1 1/2")	1.40	1.50	Ø50	25.0 / 6.5	850 / 225
DN50 (2")	2.00	1.90	Ø63	40.0 / 10.5	1350 / 357
2 1/2"	2.50	2.30	Ø75	60.0 / 16	1850 / 357
DN80 (3")	3.10	2.90	Ø78	90.0 / 24	2800 / 739
DN100 (4")	4.00	3.80	Ø96.50	125.0 / 33	4350 / 1149

Installation Positions

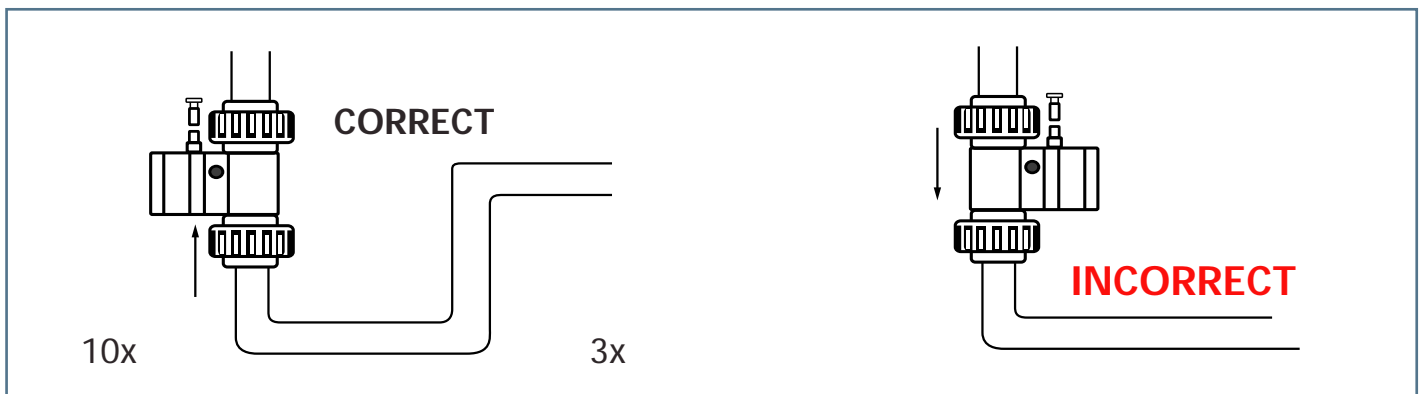
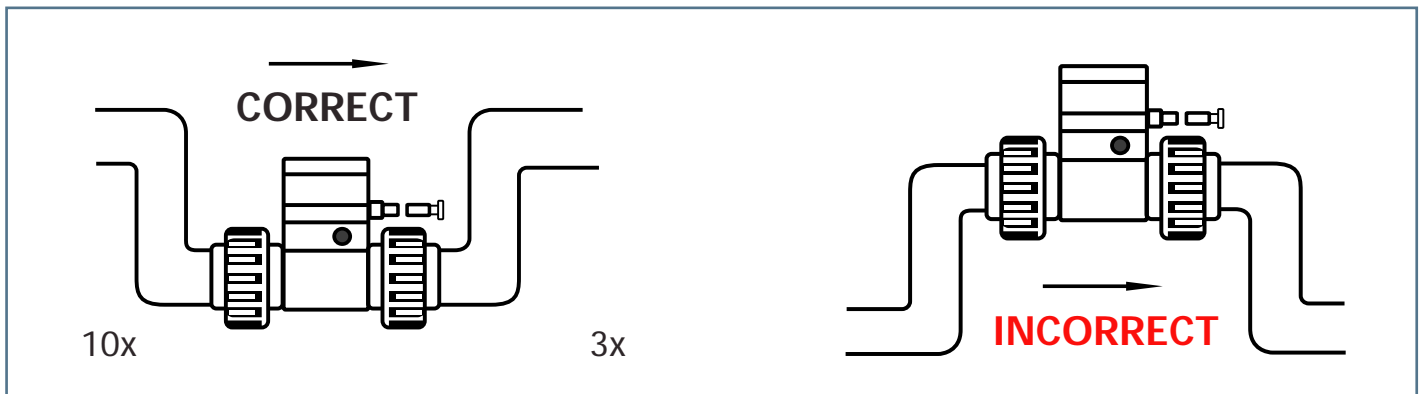
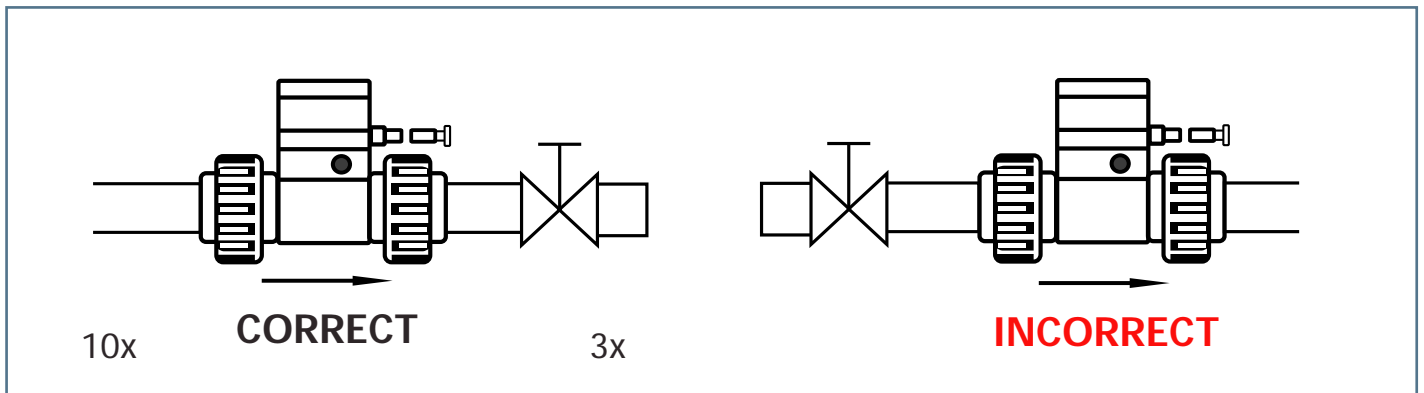
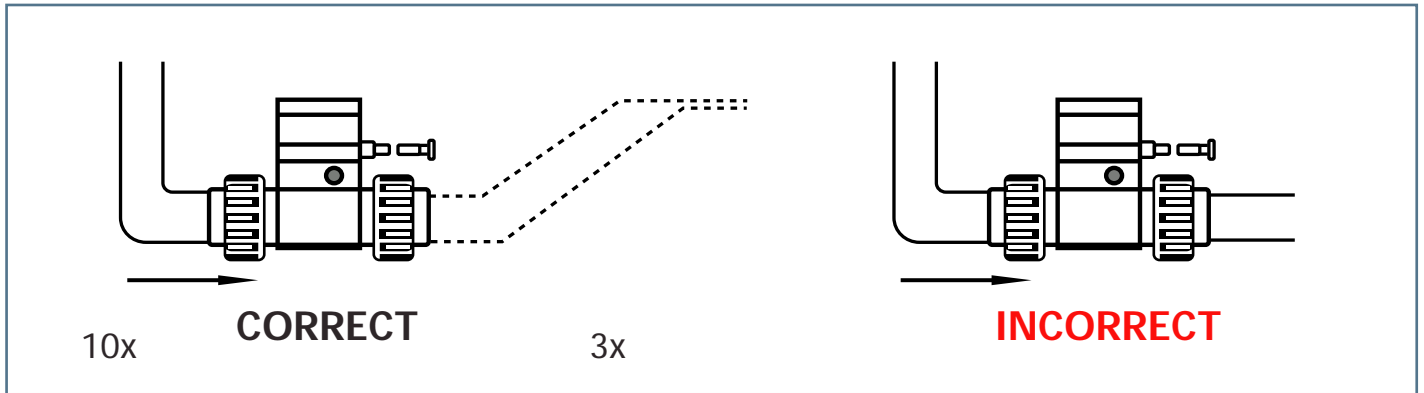

Installation Positions

Please make sure the pipe is filled with the fluid under normal operation.

TK Series can be installed in a horizontal or vertical direction.

Please ensure enough length of straight pipe to avoid turbulence that can effect readings.

Note: Min 10x Pipe Diameters Upstream 3x Pipe Diameters Downstream.

A Plastic Basket Strainer, Bag Filter or Y Strainer Filtering Device upstream to Avoid the Paddle Wheel from being damaged by the solids or fibers - max 10% Particle Size - Not to Exceed .5mm Cross Section or Length.

Please do not flush the pipe after the Flow Meter is installed with Compressed Air this may damage the ceramic shaft and will Void Warranty

