

TIW SERIES

Paddle Wheel Flow Meter



TIW SERIES

INSTRUCTION MANUAL



 **Corrosion-Free**
Instrumentation Equipment



Read the User's Manual Carefully.
Manufacturer Reserves the Right to Implement Changes Without Prior Notice.

Safety Information

1. De-pressurize and Vent System Prior to Installation or Removal.
2. Confirm Chemical Compatibility Before Use.
3. DO NOT Exceed Maximum Temperature or Pressure Specifications.
4. ALWAYS Wear Safety Goggles or Face-Shield During Installation and/or Service.
5. DO NOT Alter Product Construction.



Warning | Caution | Danger

Indicates a potential hazard. Failure to follow all warnings may lead to equipment damage, injury, or death



Hand Tighten Only

Overtightening may permanently damage product threads and lead to failure of the retaining nut.



Note | Technical Notes

Highlights additional information or detailed procedure.



Do Not Use Tools

Use of tool(s) may damage product beyond repair and potentially void product warranty.



WARNING!

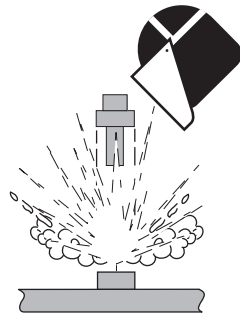

Personal Protective Equipment (PPE)

Always utilize the most appropriate PPE during installation and service of Truflo products.



Pressurized System Warning

Sensor may be under pressure, take caution to vent system prior to installation or removal. Failure to do so may result in equipment damage and/or serious injury.

General Data

Specification	Description
Operating Voltage	10 - 30VDC
Current Consumption	10mA max.
Pulse Output	NPN PNP
Fluid	H ₂ O Liquid Chemicals
Accuracy	± 0.5% of F.S. @ 25°C
Response Frequency	5K Hz
Max Flow Rate	10m/s 33ft/s
Min Flow Rate	0.1m/s 0.3ft/s
O-Ring Material	Viton (std) EPDM*
Operating Temperature	PVC < 60°C PP < 80°C PF < 100°C
Protection Class	IP-65 General Purpose
Material of Tube	Paddle Tefzel® Rotor Busings Zirconium Ceramic Sensor Body PVC PP PVDF
Approval	CE RoHS

*Optional

Installation



Very Important

- Lubricate O-rings with a Viscous Lubricant Compatible with the Materials of Construction.
- Using an Alternating | Twisting Motion Carefully Lower the Sensor into the Fitting. | Do Not Force | Fig 5
- Ensure Tab | Notch are Parallel to Flow Direction | Fig-2



Hand Tighten the Sensor Cap. **DO NOT** use any tools on the sensor cap or the cap threads or fitting threads may be damaged. | Fig-5

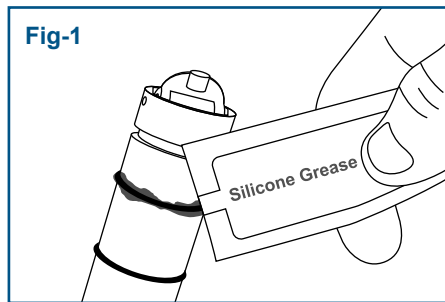

Fig-1

Ensure Amble Silicon Grease (Supplied) is Applied Prior to Insertion

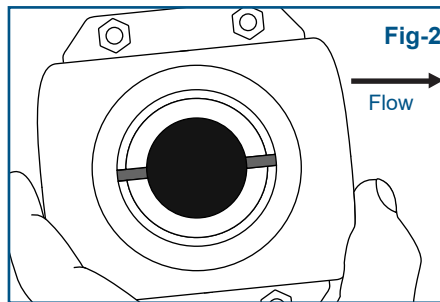

Fig-2

Ensure Location Tabs Are Parallel to Direction of Flow

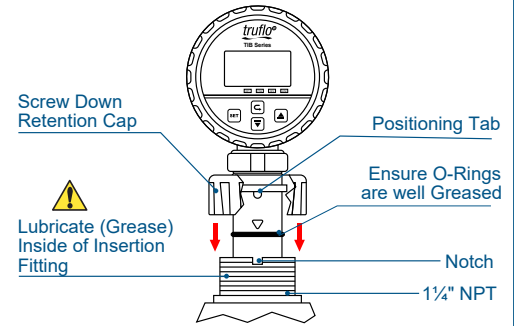

Fig-3

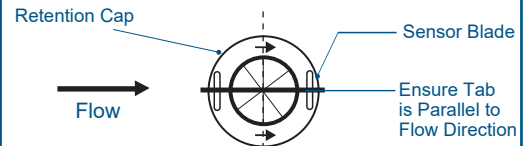

Fig-4

Process Pipe (Top View)

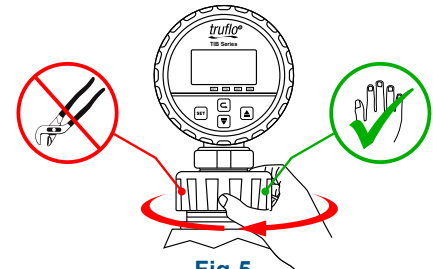
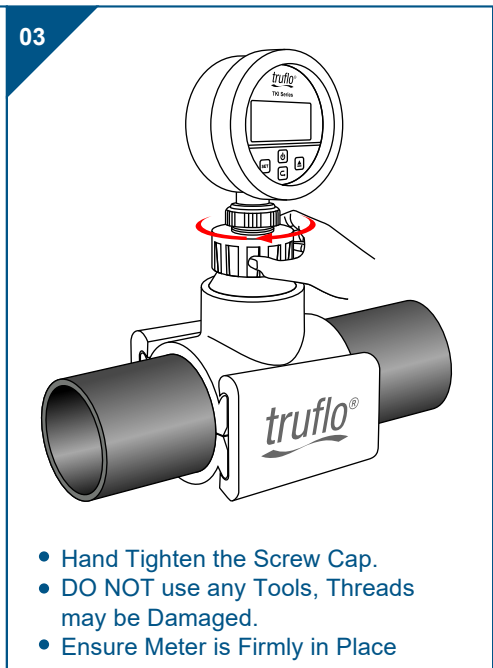
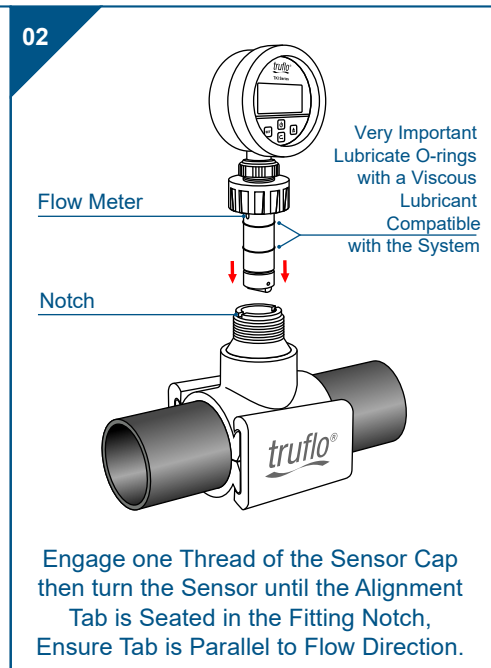
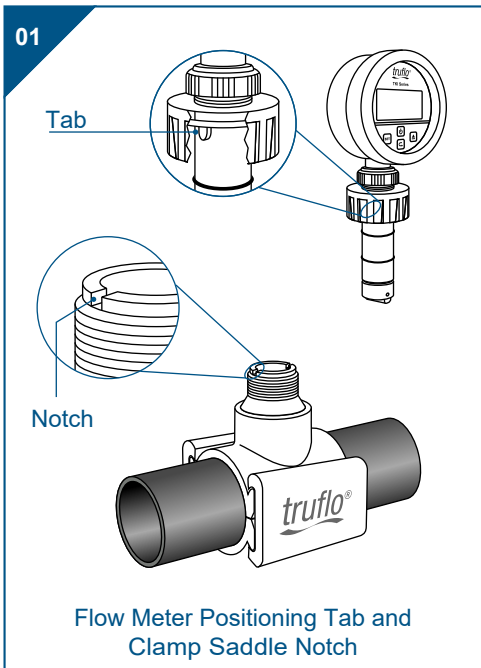

Fig-5

Correct Sensor Installation



Correct Sensor Positioning

TIW Series Flow Meters measure liquids only. No air bubbles should be present and the pipe **must always be full**. The sensors are not effective in laminar or transitional flow applications. Minimum Reynolds number required is 4500. For accurate flow measurement there must be a developed turbulent velocity profile at the sensor location. This requires a straight run pipe with a minimum number of pipe diameters distance upstream and downstream of the flow sensor. These distances depend on the type of piping element (i.e. valves, elbows, reducers etc.) causing the disturbance. To ensure maximum accuracy, the following guidelines need to be observed when installing.

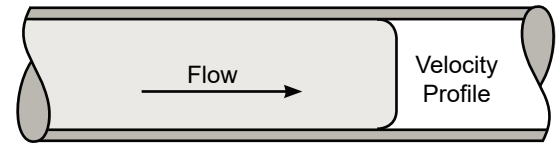

Developed Turbulent Flow

Flange

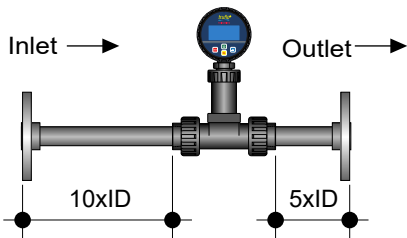

2 X 90° Elbow

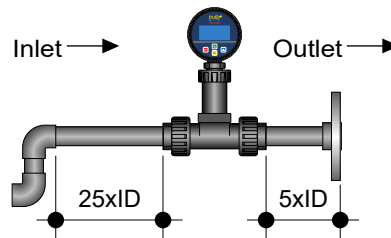

Reducer

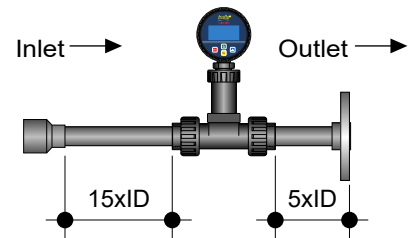

90° Elbow | Flow Downward

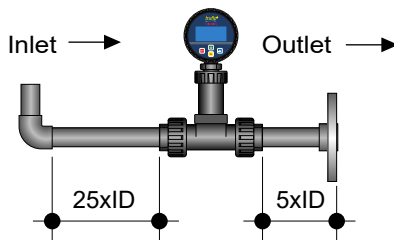

90° Elbow | Flow Upward

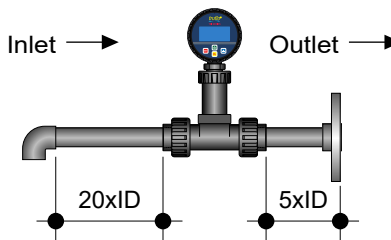

Ball Valve

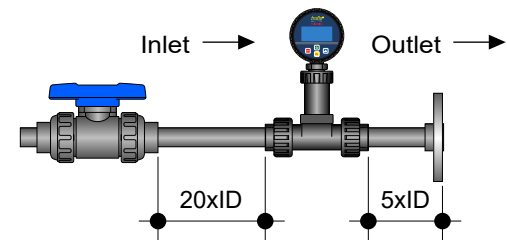

Installation Positions

Figure 1

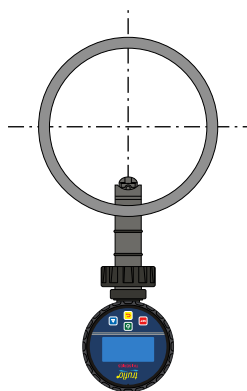

Good if NO Sediment Present

Figure 2

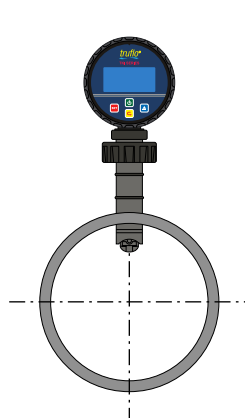

Good if NO Air Bubbles Present

Figure 3

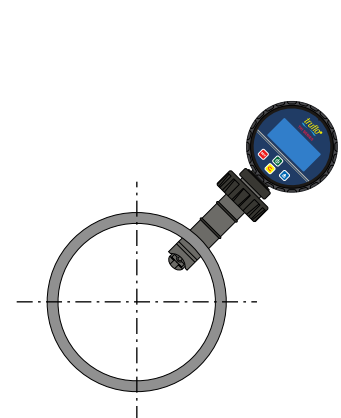

Preferred Installation if Sediment* or Air Bubbles may be Present

* Maximum % Solids: 10% with particle size not exceeding 0.5 mm cross section or length.

Long Service Life

The TIW Series is equipped with a Zirconium Ceramic Rotor Pin and 2 Bushings. The TIW Series also incorporates a contoured, 'Low Drag' Paddle Wheel leading to reduced drag, longer wear and a higher accuracy.

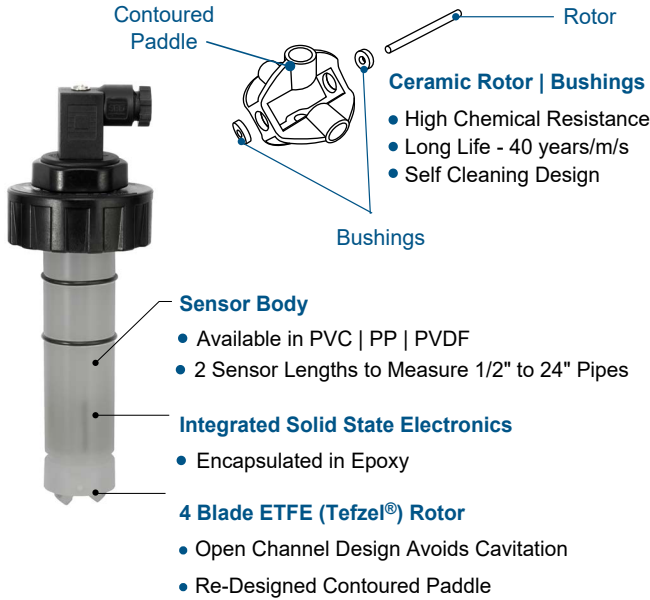

Maximum Pressure | Temperature

Note: During system design the specifications of all components must be considered. | Non-Shock

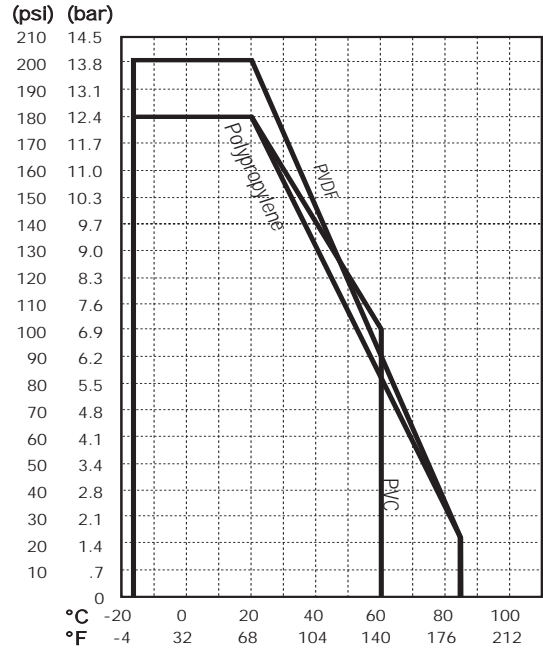

Dimensions | Wiring

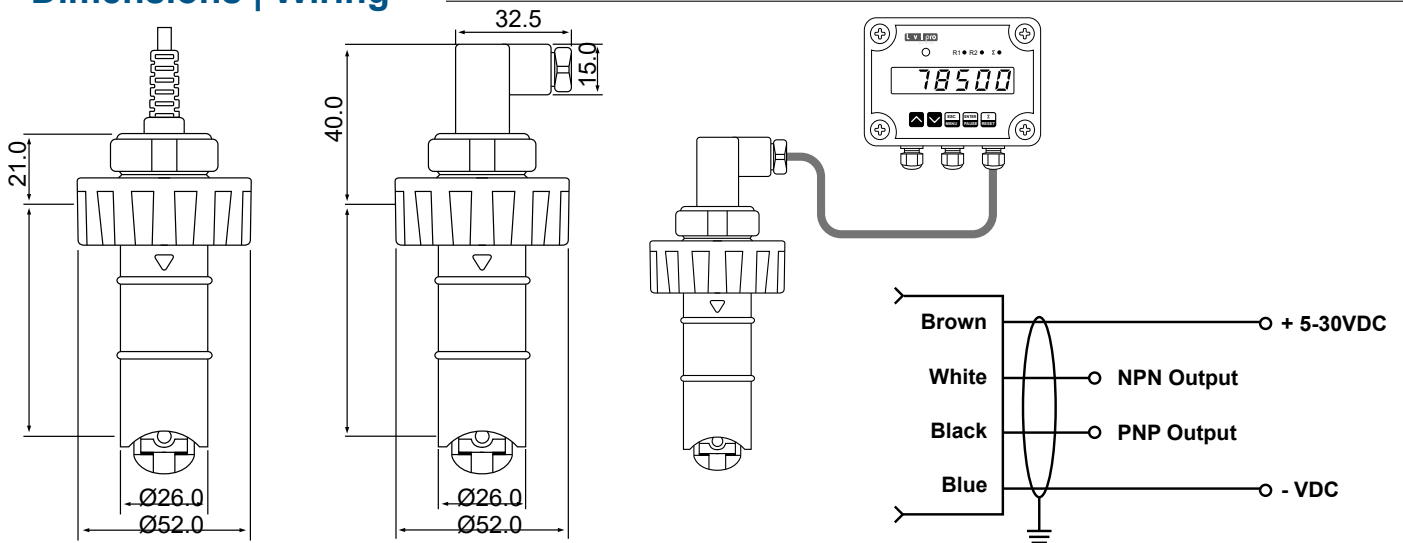



Rotor Pin | Paddle Replacement Procedure

<p>01 Line up Pin with Rotor Hole</p> <p>Small Pin</p> <p>Rotor Hole</p>	<p>02 GENTLY tap pin with Mallet or Hammer</p> <p>GENTLY tap pin with Mallet or Hammer</p>	<p>03 Tap until Rotor is 50% out</p>
<p>04 Pull out Rotor Pin</p>	<p>05 Paddle</p> <p>Paddle</p> <p>Pull Out Rotor Pin entire way until Paddle Wheel is loose</p>	<p>06 Insert New Paddle in Flow Meter</p> <p>Insert New Paddle in Flow Meter</p>
<p>07 Push in Rotor Pin approx. 50%</p>	<p>08 GENTLY tap Rotor Pin with Mallet or Hammer</p> <p>GENTLY tap Rotor Pin with Mallet or Hammer</p> <p>Ensure Holes are Aligned</p>	<p>09 Congratulations! Replacement Procedure Complete!</p>

Min | Max | Flow Rates

Pipe Size (O.D.)	ANSI (ID) (Inches)		DIN (ID) (mm)	Flow Rate (LPM) / USGPM	
	Sch (40)	Sch (80)		0.3m/s min.	10m/s max.
1/2" DN15	0.62	0.55	Ø20	3.5 1.0	120 32
3/4" DN20	0.82	0.74	Ø25	5 1.5	170 45
1" DN25	1.00	0.96	Ø32	9 2.5	300 79
1 1/2" DN40	1.40	1.50	Ø50	25 6.5	850 225
2" DN50	2.00	1.90	Ø63	40 10.5	1350 357
2 1/2"	2.50	2.30	Ø75	60 16	1850 357
3" DN80	3.10	2.90	Ø78	90 24	2800 739
4" DN100	4.00	3.80	Ø96.50	125 33	4350 1149
6" DN150	6.06	5.70	Ø150	230 60	7590 1997
8" DN200	7.94	7.56	Ø200	315 82	10395 2735

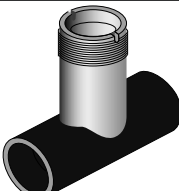
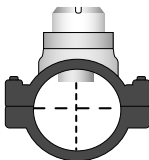
K Factor Tables

TEE FITTINGS					CLAMP-ON SADDLES					CPVC SOCKET WELD-ON ADAPTERS							
																	
Tee Fitting (Unit:inch)			K-Factor		Sensor Length	Clamp Saddles			K-Factor		Sensor Length	Tee Fitting (Unit:inch)			K-Factor		Sensor Length
Size	DN	Id	CPVC SCH80			Size	DN	Id	CPVC SCH80			Size	DN	Id	CPVC SCH80		
1/2"	15	0.55	1013.04		S	2"	50	1.9	81.65		S	2"	50	1.9	81.65		S
3/4"	20	0.74	604.80		S	3"	65	2.3	34.96		S	2-1/2"	65	2.3	54.43		S
1"	25	0.96	408.24		S	4"	80	2.9	19.80		S	3"	80	2.9	34.96		S
1-1/4"	32	1.30	250.40		S	6"	100	3.8	9.18		L	4"	100	3.8	19.80		S
1-1/2"	40	1.50	139.86		S	8"	150	5.7	5.21		L	6"	150	5.7	9.18		L
2"	50	1.90	81.65		S							8"	200	7.0	5.21		L
2-1/2"	65	2.30	54.43		S							10"	250	9.5	3.43		L
3"	80	2.90	34.96		S							12"	300	11.3	2.45		L
4"	100	3.83	19.80		S							14"	350	12.4	1.77		L
												16"	400	15.1	1.36		L
												20"	500	19.0	0.86		L
												24"	600	21.0	0.60		L

Warranty Information

All warranty and non-warranty repairs being returned must include The RGA number and a fully completed Service Form and Flow Meter. must be returned to Icon Process Controls directly or to the authorized distributor. Product returned without a RGA number and Service Form will not be warranty replaced or repaired. Truflo Flow Meters are warranted out of box but not against any damage, due to Process or Misapplication Failures e.g. High Temperature, Chemical Attack or Physical Mishandling of Product.

Experience the ICON Difference
North America's Largest Inventory
Industry Leading Technology
www.iconprocon.com

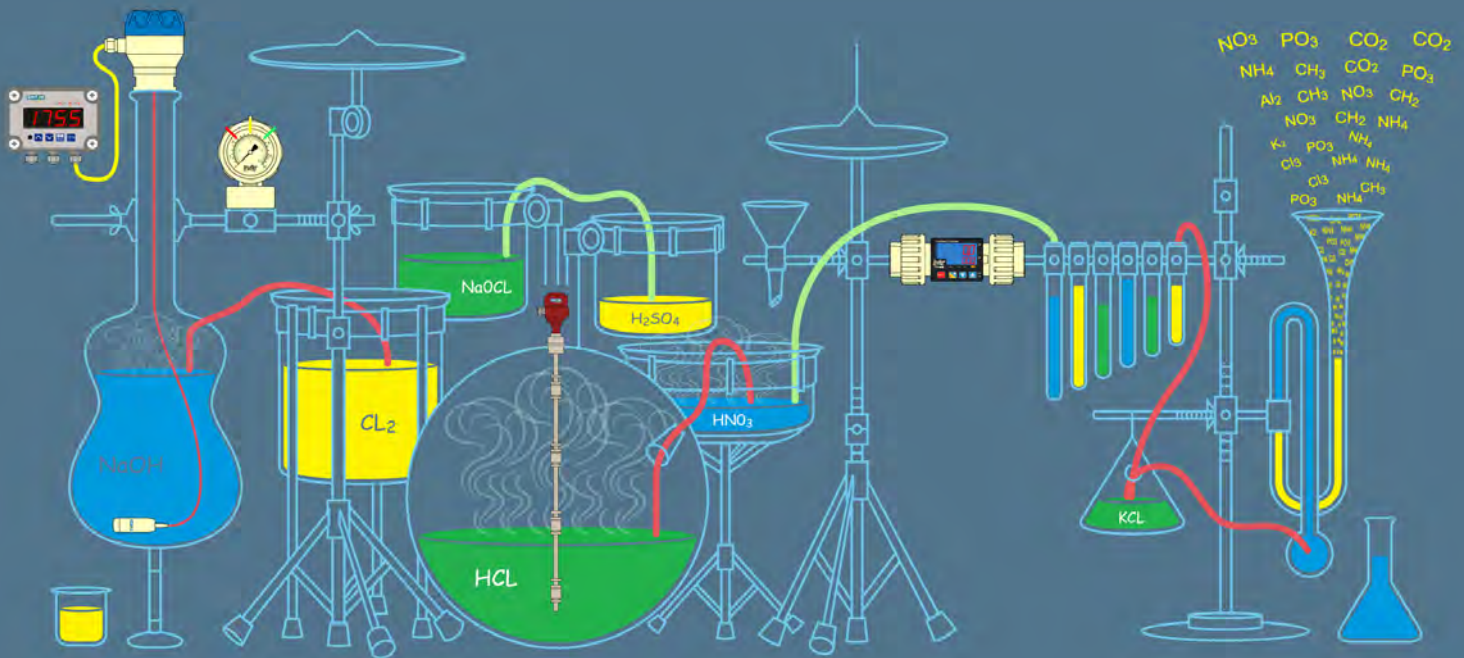

We Measure & Control
All Kinds of Corrosive Liquid S#*%

FLOW + PRESSURE + LEVEL + TEMP